

# Meaco DD8L Zambezi Dehumidifier



*Thank you for choosing Meaco, we really do appreciate it*

**INSTRUCTION MANUAL [EN]**  
*DD8L Zambezi*

## SAFETY INFORMATION

### ATTENTION

This dehumidifier must not be used in rooms under the following conditions:

- Potentially explosive atmosphere
- Aggressive atmospheres
- Featuring a high concentration of solvents
- An extremely high ratio of dust
- For use in domestic applications only

**Keep Children and Pets Away:** Do not allow children or pets to play with or around this unit, which could result in injury. Be sure the unit is inaccessible to children when not attended. This appliance can be used by children aged from 8 years and above and persons with reduced physical, sensory or mental capabilities or lack of experience and knowledge if they have been given supervision or instruction concerning use of the appliance in a safe way and understand the hazards involved.

**Keep Unit Grounded:** Always operate the unit with a grounding plug and a grounded electrical outlet. A grounding plug is an essential safety feature that helps reduce the risk of shock or fire.

**Protect Power Cord from Damage:** Do not run power cord under carpeting, or cover with rugs or runners. Arrange the cord away from areas where it may be tripped over. Never operate a unit with a damaged power cord, as this may lead to electrical or fire hazards. If the power supply cord is damaged, it must be replaced by a cord of the same type and amperage rating.

**Extension Cords:** Where possible, avoid the use of an extension cable as they may overheat and cause a risk of fire. Only use an extension cord after ensuring it is in perfect condition. Extension leads can also cause voltage drop which will affect the dehumidifier. This is more likely when being used in garages and out buildings.

**Handle with Care:** Do not drop, throw or crash the dehumidifier. Rough treatment can damage the components or wiring and create a hazardous condition.

**Run on Stable Surface:** Always operate the unit on a stable, level surface, for example the floor or a strong counter, so that the dehumidifier cannot fall and cause injury.

**Keep Out of Water:** Never operate the unit in pooled or standing water, as this may create a risk of injury from electrical shock. Do not store or operate outdoors. If electrical wiring or components become wet, thoroughly dry them before using the unit. If in doubt do not use the dehumidifier and consult a qualified electrician or a Meaco approved engineer.

**Keep Air Intakes Clear:** Do not clog or block the air intakes by placing the dehumidifier too close to curtains, walls or anything that will restrict the air inlet. This may cause the unit to overheat and result in a fire or electrical hazard.

**Keep Filter Clean:** Always use a clean air filter. Do not allow any material to clog the filter, as this may cause the dehumidifier to overheat. Never use without a filter. Always check, and if necessary, clean the filter before switching the dehumidifier on. Do not allow oil, grease, or other contaminants to be drawn into the dehumidifier. Do not clean the dehumidifier with organic solvents.

**A Clean Filter is Important:** Check the filter regularly in order to keep it clean as per the instructions in this manual. A dirty filter will restrict the air flow into the machine which will increase the resistance on the fan and could result in damage and might invalidate the warranty.

**Keep Electrical Components Dry:** Never allow water inside the dehumidifier's electrical components. If these areas become wet for any reason, thoroughly dry them before using the dehumidifier. If in doubt do not use the dehumidifier and consult a qualified electrician or a Meaco approved engineer.

**The Operator Must** make the operating instruction available for the user and make sure that the user does understand the manual.

**When using the "Laundry" mode:** For the drying of wet clothes in the room, keep the clothing at a safe distance from the unit to prevent water from dropping onto the unit.

**Turning off:** Never unplug the power cord without press the "Power" key to off first, as this could damage the unit. Never unplug the dehumidifier before the fan has stopped blowing. Always unplug the unit when not in use or moving location. To disconnect from the power supply, grip the plug and pull from the power socket. Never pull by the cord.

**Repairs:** To repair the unit, take it to a qualified service engineer. Repairs carried out by unqualified people may cause damage to the unit or injury to persons or property and void the warranty.

## British Plug Wiring

**Wiring Instructions:** Should it be necessary to change the plug please note the wires in the mains lead are coloured in accordance with the following code:

BLUE - NEUTRAL  
BROWN - LIVE  
GREEN AND YELLOW – EARTH

As the colours of the wires in the mains lead of this appliance may not correspond with the coloured markings identifying the terminals in your plug, proceed as follows:

1. The **BLUE** wire is the **NEUTRAL** and must be connected to the terminal which is marked with the letter **N** or coloured **BLACK**.
2. The **BROWN** wire is the **LIVE** and must be connected to the terminal which is marked with the letter **L** or coloured **RED**.
3. The **GREEN/YELLOW** is the **EARTH** and must be connected to the terminal which is marked with the letter **E** or coloured **GREEN OR GREEN/YELLOW**.
4. Always ensure that the cord grip is positioned and fastened correctly.

If a 13A (BS1363) fused plug is used it must be fitted with a 13A fuse. If in doubt consult a qualified electrician.

Wiring for a 13Amp Plug (BS1363)

Please note. The Earth Terminal is marked with the letter **E** or Earth Symbol .

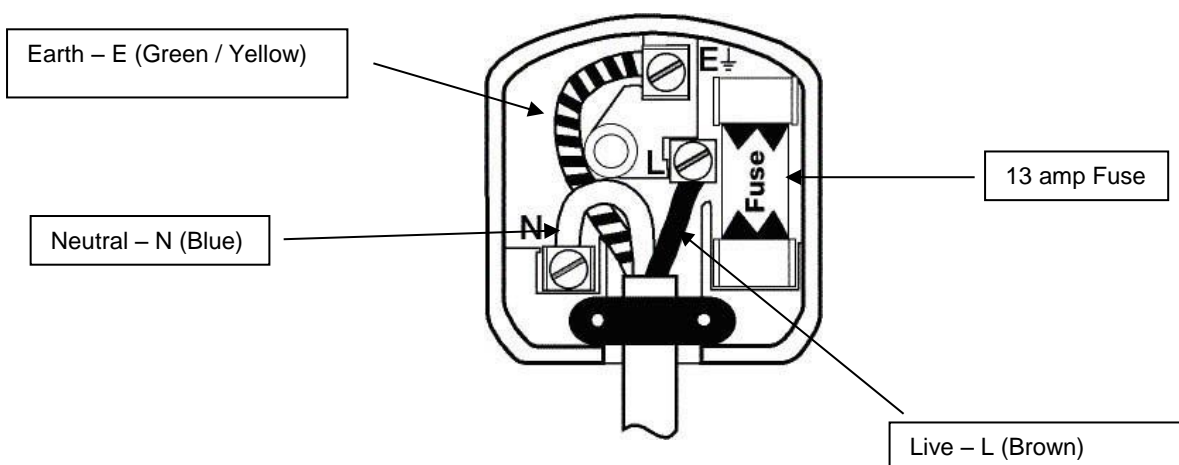

## 1. GENERAL ADVICE

**Before** putting your dehumidifier into operation for the first time, the instruction manual should be studied carefully.

**After receiving the unit**, you should check your dehumidifier for any transport damage. In case of damage, you should inform the sender immediately.

**Keep the packaging** for the dehumidifier in a safe place in order to be able to despatch the dehumidifier safely if it requires a service. In order to save space, you can simply cut through the adhesive tape using a knife and fold up the cardboard box. Please keep all packaging away from children and recycle the packaging if you do decide to dispose of it.

## 2. DEHUMIDIFIER PRINCIPLES

There are four types of dehumidifier sold to the domestic market in Europe - compressor, desiccant (this dehumidifier), peltier and silica gel.

A desiccant based dehumidifier draws the air in from the room over a filter and passes it over a rotating wheel that is full of a material called Zeolite which absorbs the excess water out of the air. The wheel is now saturated and needs to be regenerated. A heater in the lower half of the dehumidifier and a second fan work together to regenerate the desiccant by pulling the damp air out of the wheel through a combination of the air flow and the heat. The desiccant is now ready to dry the air again and the warm, wet air from the wheel goes into the plastic condenser tubes and is cooled by the air coming in from the room which allows the moisture to condensate and the water drips into the internal tank. The heat used during the drying process is mixed with the dry air to ensure that the air that comes out of the dehumidifier is not just drier but 10-12°C warmer than the air that came in.

## 3. INSTALLATION AND INITIAL USE

- Place the dehumidifier in an upright position on a stable, flat surface.
- Please ensure the unit is a safe distance away from a wall or furniture.
- Please keep clothes at a safe distance of 30cm away from the air inlet or outlet to prevent water from dripping into the unit.
- Ensure the tank is correctly fitted, if the tank is full or is not in place, the "Empty Tank" light comes on, an alarm will sound and the dehumidifier will turn off.
- To turn the dehumidifier on press the Enter button for two seconds, you will hear a beep.
- To turn the dehumidifier off press the Enter button for two seconds, the machine will turn off.

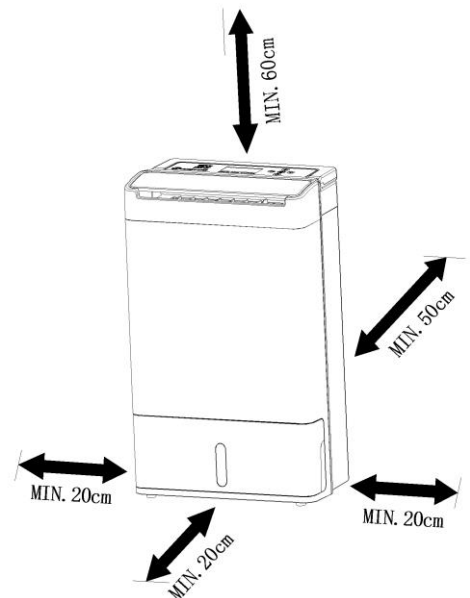

### Where to position the dehumidifier

- For best results position the dehumidifier somewhere central like a landing or a hallway. As long as the internal doors are open the moisture will migrate naturally towards the dehumidifier to be processed.
- To dry washing it is best to put the dehumidifier into a small room. Close the door and windows and use the dehumidifier in "Laundry" mode. Hang the clothes so that they are not touching each other and so that air can circulate between the clothes. Ensure that water does not drip onto the dehumidifier.

### Smell coming from the dehumidifier

When you first use the dehumidifier and periodically afterwards you might notice a smell coming from the dehumidifier. This is caused by the Zeolite desiccant material mixing with chemicals within your home and is not a sign that the dehumidifier is faulty, nor is it harmful to humans or pets. The smell occurs because the Zeolite absorbs odours from the air from items like cigarettes, cosmetics, hair sprays, building materials and new furniture. These chemicals mix together within the desiccant and then when the desiccant is heated the new smell is discharged into the room. This smell has been described as being like a burning smell or a sour smell. It is normal, will not last long and is not a sign of a fault. You can clear it by running the dehumidifier in a separate space like a garage or if it is dry – outside.

### Amount of water collected

When you first use your dehumidifier it will work harder to reduce the room humidity down to the target you select. This is the time when it will produce the most water and need emptying most frequently. As the room becomes dryer the dehumidifier collects less water and takes longer to fill the tank, this is perfectly normal. When the target relative humidity has been reached the dehumidifier will stop collecting water, again this is normal.

If you find that you still have condensation on your windows or you need to dry the air further then use a lower relative humidity as your target. This might well be necessary if you have single glazed windows or if the outside air temperature drops towards freezing.

Although the Laundry mode aims for a lower relative humidity it will reach a point after which there will be no more water to collect because it will not over dry the air below a point at which the air will become uncomfortable (around 38%rh).

### To operate safely

- Do not insert small objects into the unit or this will damage it and cause a hazard.
- Do not remove the tank when the dehumidifier is running or water may leak.
- Minimum operating condition 1°C at 40%rh relative humidity.

## 4. PRODUCT IDENTIFICATION

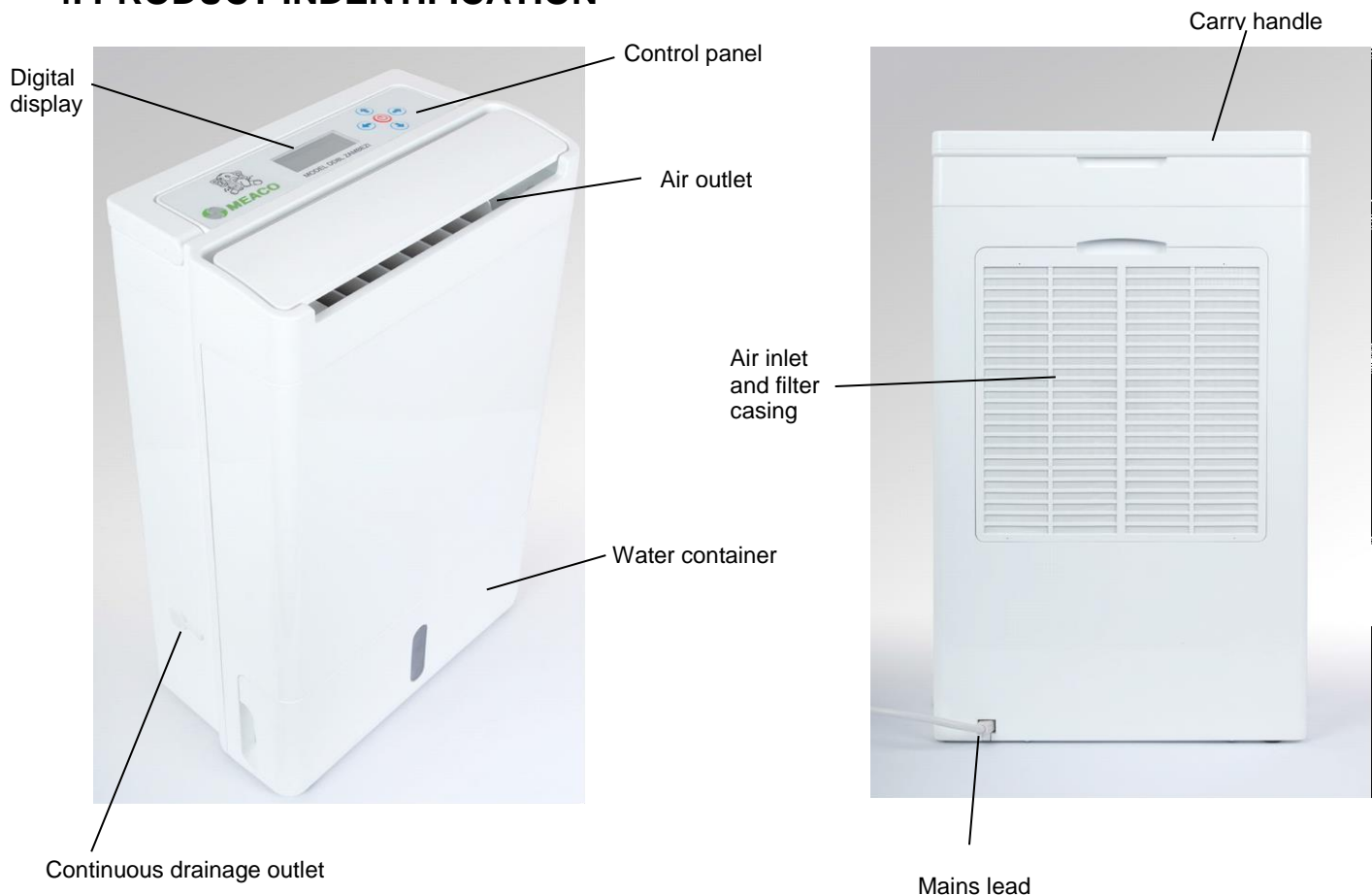

## 5. WATER COLLECTION

This dehumidifier contains a built-in tank where the water will automatically drip into. When the bucket is full the dehumidifier will turn off so that it cannot overflow.

### Bucket full, time to empty the dehumidifier

	<p>When the water collection tank is full the dehumidifier will bleeper will sound ten times and Zambezi will turn off. Once you have emptied and refitted the tank then Zambezi will start to work again as per his previous settings.</p>
---	---

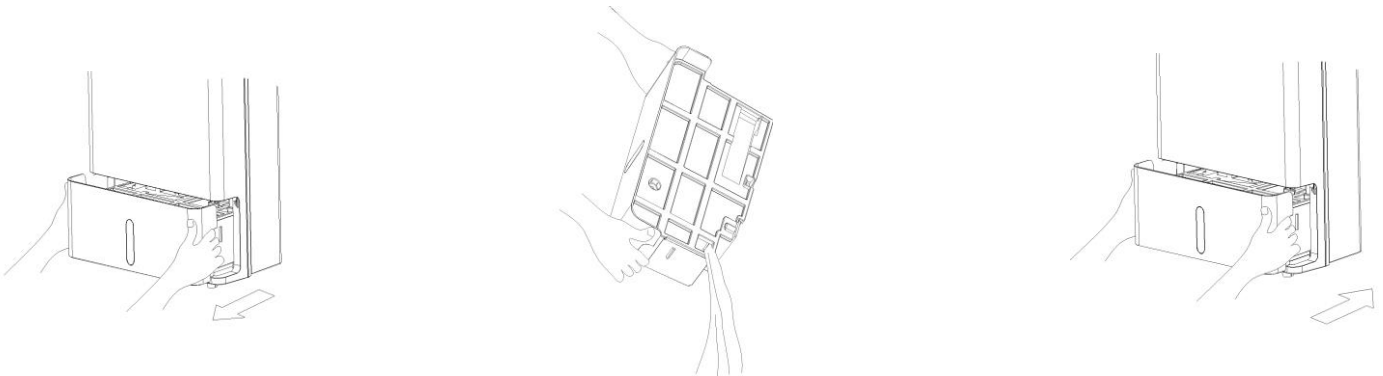

If you wish to drain the water away continuously this can be done via the side water outlet as per below. Please ensure that the hose runs downwards, if the hose is blocked, kinked or runs uphill then the water will drain back into the tank and the dehumidifier will turn off when this is full.

1. Remove the drain hole cover on the side of the dehumidifier and push the hose into the hole.



2. Remove the bucket, push back the drip stopper and push the hose onto the water outlet.

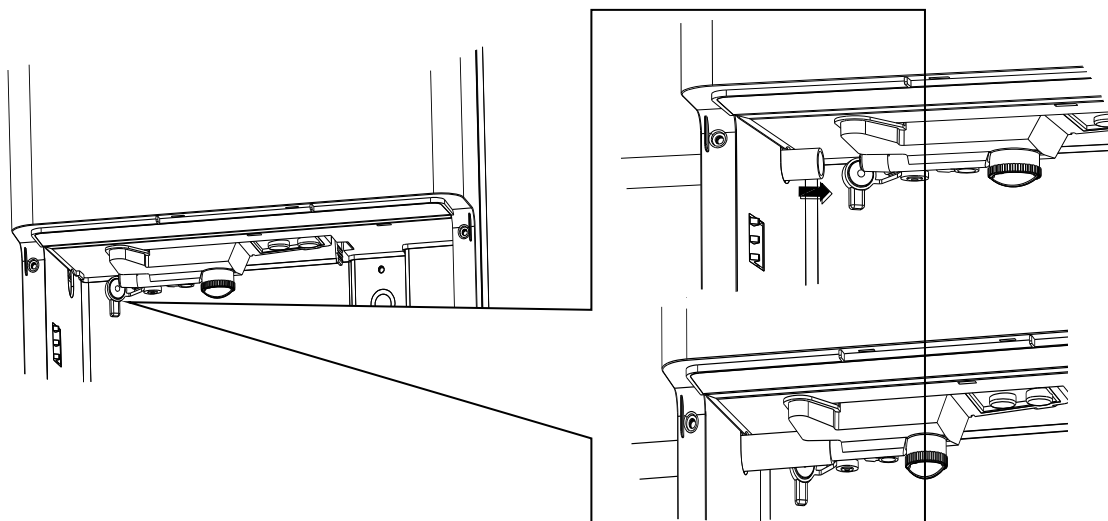

3. Reinsert the bucket and make sure that the hose runs downhill.

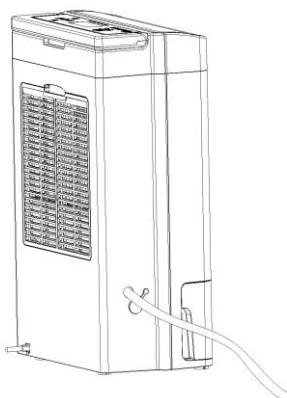

If you find that the water is flowing back into the tank but the hose is running perfectly downhill with none of the above problems then make a 4mm diameter hole in the top of the hose 30mm from the dehumidifier to allow air into the top of the hose and to balance out the air pressure imbalance that is stopping the water from flowing.

## 6. OPERATION

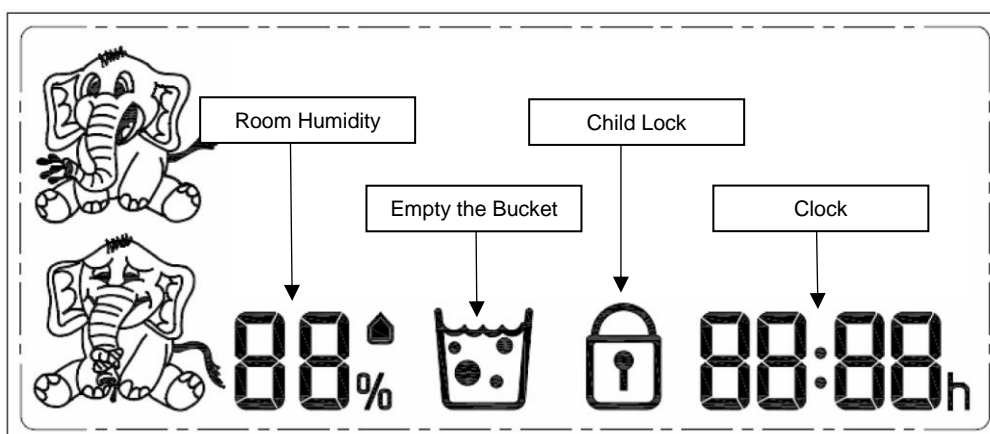
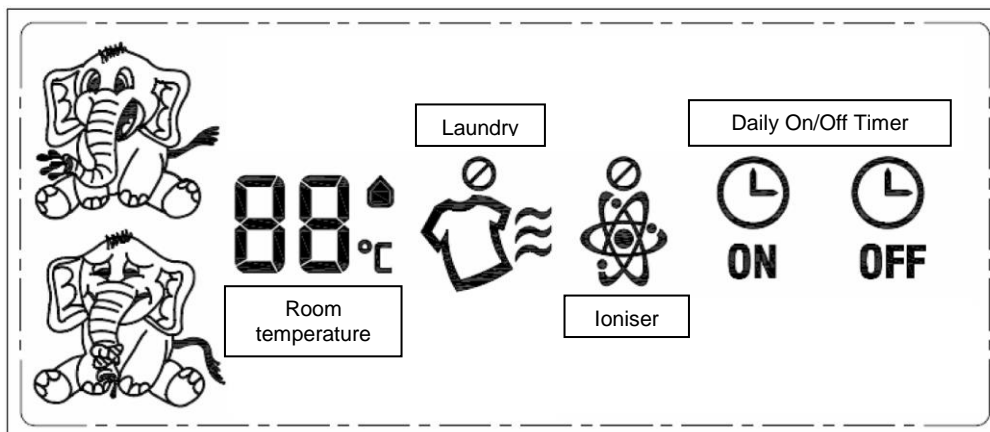
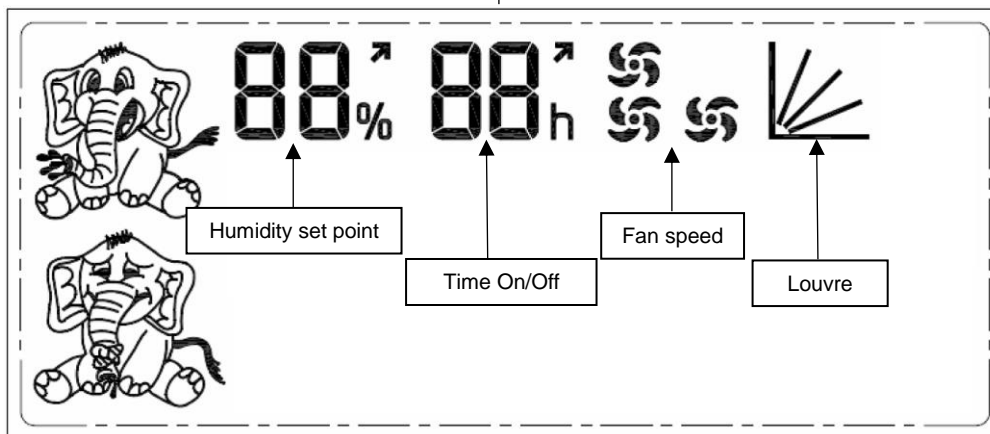
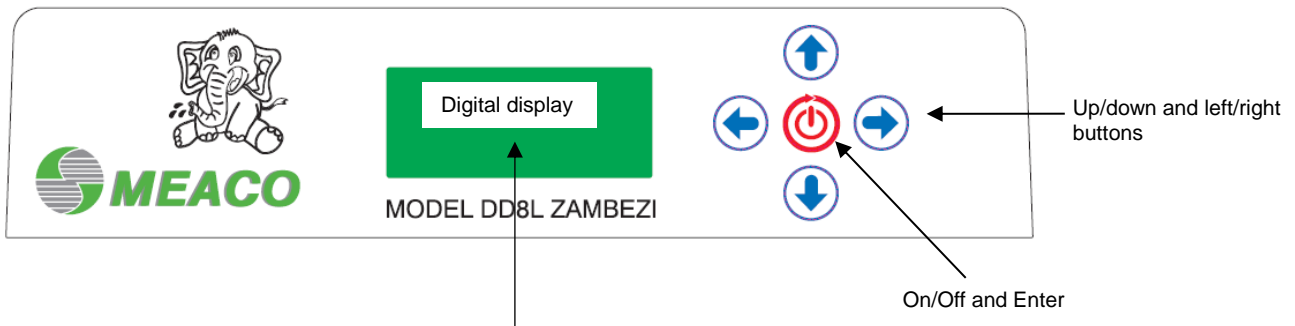





## Using your dehumidifier – basic options

- Use the Left or Right button to move between options.
- Use the Up and Down arrows to edit settings.
- Use the Left or Right button to save your changes and to move onto another option OR use the Enter button to save changes and exit.
- If you don't press a button for 10 seconds then no changes are saved and Zambezi will come out of editing mode.

### ⇒ Turning Zambezi On or Off

	<p>Press the red Enter button for 2 seconds to turn the unit ON or OFF.</p> <p><i>With all desiccant dehumidifiers it is important that they are able to cool down after dehumidifying to get rid of the heat that has built up inside them during operation. This is why when you press the Off button the fan keeps running for ten minutes before the machine turns off. This action is normal and you should let Zambezi do this and not unplug him until this cool down has finished.</i></p>
---	--

### ⇒ Setting the target relative humidity

	<p>Press the Left or Right button to move to the relative humidity setting at the top left of the screen.</p> <p>Use the Up or Down arrow to select your preferred relative humidity level. To save press Right button to move to the next option or Enter to finish.</p> <p>You can choose a target relative humidity between 40 and 70%rh. 'CO' means Continuous and Zambezi will dehumidify constantly.</p>
---	--

### ⇒ Setting the fan speed

	<p>Press the Left or Right button to move to the fan speed setting.</p> <p>Use the Up or Down arrow to select your preferred fan speed.</p> <p>To save press the Left or Right button to move to the next option or Enter to finish.</p>
---	--

### ⇒ Setting the louvre angle

	<p>Press the Left or Right button to move to the louvre angle setting.</p> <p>Use the Up or Down arrow to select your preferred angle.</p> <p>To save press the Left or Right button to move to the next option or Enter to finish.</p> <p><i>Up angle = 85 to 25°</i> <span style="float:right"><i>Middle angle = 55 to 0°</i></span></p> <p><i>Bottom angle = 25 to 0°</i> <span style="float:right"><i>Wide angle = 85 to 0°</i></span></p>
---	--

The above is all you need to do for day to day operation. The current relative humidity and temperature within the room is displayed at the bottom left of the display.

## Using your dehumidifier – Advanced options



### ⇒ Off timer

	<p>Press the Left or Right button to move to the hours setting on the top row.</p> <p>Use the Up or Down arrow to select your preferred countdown time. To save press the Left or Right button to move to the next option or Enter to finish.</p> <p>The machine will turn off (and will not come back on) after the number of hours that you have selected.</p> <p><i>This mode is useful to turn Zambezi off after a set period of drying time – for example when drying washing.</i></p>
---	---



### ⇒ On timer

	<p>When the dehumidifier is turned off and is in Standby mode then you can press the Right button to move to the hours setting on the top row.</p> <p>Use the Up or Down arrow to select your preferred countdown time. To save press the Left or Right button to move to the next option or Enter to finish.</p> <p>The machine will turn on after the number of hours that you have selected.</p> <p><i>This mode is useful to turn Zambezi on in a few hours time – for example when you go to bed so that it turns on when you are in a deep sleep.</i></p>
---	---

### ⇒ Laundry Mode

		<p>Press the Left or Right button to move to the Laundry setting on the middle row. Use the Up or Down arrow to select Laundry on or Off.</p> <p>To save press the Left or Right button to move to the next option or Enter to finish.</p>
	<p>Laundry Off</p>	<p>When Laundry is on any changes you make to the fan speed or the target relative humidity will only come into effect when you turn the Laundry function off.</p>
	<p>Laundry On</p>	<p><i>Zambezi Laundry mode is cleverer than other dehumidifiers and saves a lot of energy. When the room relative humidity reaches 35%rh then Zambezi will half its energy consumption to 300 watts. If the relative humidity then falls below 35%rh the heater will turn off completely and only the fan will run. If the relative humidity then increases to above 40%rh then the heater reverts to half power and if the relative humidity continues to rise to 45%rh then the heater will resume full power.</i></p>

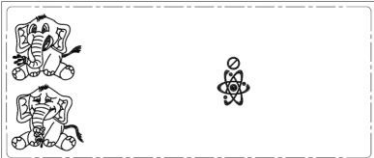
### ⇒ Anti-Bacterial, anti-germs, anti-mould spores Ioniser

		<p>Press the Left or Right button to move to the Anti-bacterial Ioniser setting on the middle row.</p>
	<p>Ioniser Off</p>	<p>Use the Up or Down arrow to select On or Off as required.</p>
	<p>Ioniser On</p>	<p>To save press the Left or Right button to move to the next option or Enter to finish.</p> <p><i>The Zambezi Ioniser is not the same as those found on other desiccant dehumidifiers which just remove dust from the air. This is a completely different type of ioniser that is clinically proven to remove germs, bacteria, mould spores, odours and ticks from the air.</i></p>

### ⇒ Setting the clock

	<p>Press the Left or Right button to move to the Time setting on the bottom row – the 'h' will flash, press Enter to edit.</p> <p>To change the Hour time press Use the Up or Down arrow as required. To save press the Right button which will also move you to the minutes.</p> <p>To change the Minutes press the Up or Down arrow as required.</p> <p>To save the new time press the Right button to move onto the next option or press Enter.</p>
--	--

### ⇒ Setting Daily On/Off Timer

	<p><b>Set the clock time first as per above.</b></p> <p>This mode controls what time the dehumidifier will come on and off at each day.</p> <p>Press the Left or Right button to move to the On/Off setting on the middle row. Change the clock using the Up/Down buttons so that the clock symbol is displayed with the word ON. Press Enter and then change the clock to read the time that you want Zambezi to turn ON at every day using the UP/Down button to set the time and the Left/Right buttons to move between Hours/Minutes.</p> <p>Once set press the Right button to edit the Off settings.</p> <p>Change the clock using the Up/Down buttons so that the clock symbol is displayed with the word OFF. Press Enter and then change the clock to read the time that you want Zambezi to turn OFF every day using the UP/Down button to set the time and the Left/Right buttons to move between Hours/Minutes.</p> <p>To save the new time press the Right button to move onto the next options or press Enter.</p> <p>To exit this mode change the clock symbols so that they are displayed without the ON or OFF displayed.</p>
---	--

⇒ **Child Lock**

	<p>Press and hold the Left or Right buttons at the same time for three seconds to turn the Child Lock on. Press and hold the same buttons for three seconds to turn the function off.</p>
---	---

**Using your dehumidifier – Other functions and Settings**

⇒ **Happy Zambezi**

	<p>Happy Zambezi appears on the display when the machine is dehumidifying and water is being collected.</p>
---	---

⇒ **Sad Zambezi**

	<p>Sad Zambezi appears on the display when the machine is NOT dehumidifying and water is NOT being collected.</p>
--	---

⇒ **Memory Function**

	<p>Elephants are known for their excellent memory and Zambezi is no different. When you turn the machine off using the On/Off button and then turn Zambezi back on he will remember the settings that you last used and will start up using those functions. The same applies after a power cut, Zambezi will start to work again just as you left him.</p> <p>If you press Up/Down/Left/Right all at the same time for 3 seconds '88' will blink on the LCD and all settings will be lost and you will have reset the dehumidifier to the original factory settings.</p>
---	---

⇒ **Turn me on!**

	<p>If you leave the machine in Standby mode (turned off but still plugged in to the mains) and the relative humidity goes above 70%rh then 'HI' will appear on the display. This is Zambezi telling you that you should turn the dehumidifier on because the room relative humidity is too high.</p>
---	--

⇒ **Bucket full, time to empty the dehumidifier**

	<p>When the water collection tank is full the dehumidifier will bleeper will sound ten times and Zambezi will turn off. Once you have emptied and refitted the tank then Zambezi will start to work again as per his previous settings.</p>
---	---

⇒ **Cool down**

	<p>With all desiccant dehumidifiers it is important that they are able to cool down after dehumidifying to get rid of the heat that has built up inside them during operation. This is why when you press the Off button the fan keeps running for ten minutes before the machine turns off. This action is normal and you should let Zambezi do this and not unplug him until this cool down has finished.</p>
---	---

⇒ **Meaco Control Logic**

	<p>Zambezi benefits from the unique Meaco Control Logic that makes him a much better dehumidifier. If you select one of the humidistat options between 40 – 70%rh then Meaco Control logic will automatically work.</p> <p>When the target relative humidity has been reached the dehumidifier will stop drying the air but the fan will continue to run for 10 more minutes. When this happens no more water will be collected, this is perfectly normal. The fan then goes to sleep for 30 minutes after which it will wake up and sample the air for 3 minutes in low fan speed so that the dehumidifier knows when to start collecting water again, but if the relative humidity remains below the target then the fan will go to sleep again for another 30 minutes and so on.</p> <p><i>It is normal to see the relative humidity reading on the display increase when the fan is off and Zambezi is asleep. This is because the reading is now displaying the relative humidity inside Zambezi which will be higher than the room reading. When the fan comes back on then the reading will be of the air from within the room.</i></p>
---	--

⇒ **Energy Consumption**

	<p>There are many features within Zambezi to help you save energy such as the unique way the Laundry function works and the Meaco Control Logic. You can also choose how much energy Zambezi consumes by understanding that in low fan speed he will be using 300 watts and in medium or high fan speed it will be 600 watts.</p>
---	---

⇒ **Meaco 20+**

	<p>If you set the dehumidifier to maintain a particular relative humidity and the room relative humidity increases to 20%rh higher than that setting then the machine will increase its fan speed to bring the relative humidity down to within 20%rh and will then drop the fan speed back down to where you set it.</p>
---	---

**ALL OF THE ABOVE FUNCTIONS CAN ALSO BE SET IN STANDBY MODE WITH THE EXCEPTION OF THE OFF TIMER WHICH CAN ONLY BE SET WHEN THE MACHINE IS OPERATIONAL.**

## 7. CLEANING

Switch the dehumidifier off and remove the plug from the socket before cleaning.

### The air filter

When used regularly, the filter may become clogged with dust and particles. Therefore the filter should be cleaned at least every two weeks. Clean the filter with a vacuum cleaner and not with water as water will damage the anti-bacterial properties of the filter.

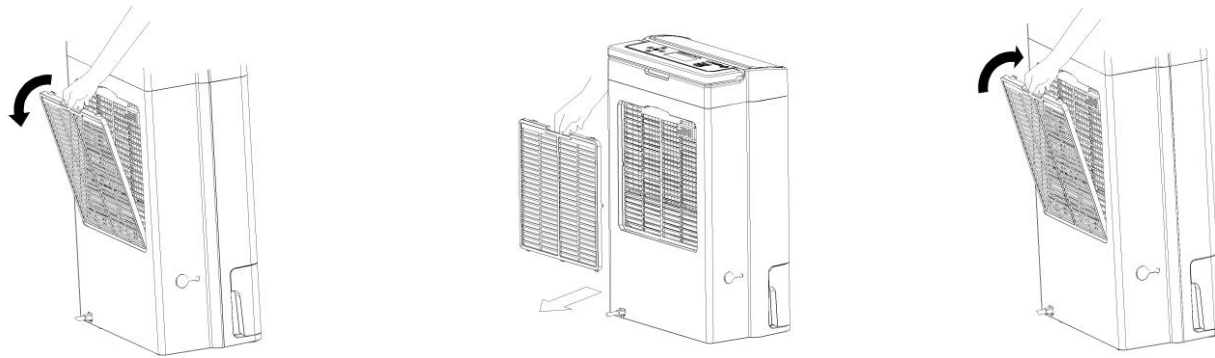

**Never use the device without the air filter or with a dirty air filter.**

### The exterior

Clean the exterior with a soft, dry cloth. If the device is extremely dirty, use a mild cleaning agent. Wipe the dehumidifier with a slightly damp cloth. Never spray the device with water.

### The drain

The most common reason why a domestic desiccant dehumidifier would leak water is a blockage in the condenser or the drain. Zambezi is unique in that you are able to clear blockages yourself without the need to refer back to your supplier or Meaco. Remove the bucket and you will see in the top of the recess one black drain flap to the right of the drain and one black screw bung in the centre. Both can be removed to clean out any dirt that has built up and is blocking the flow of the water.

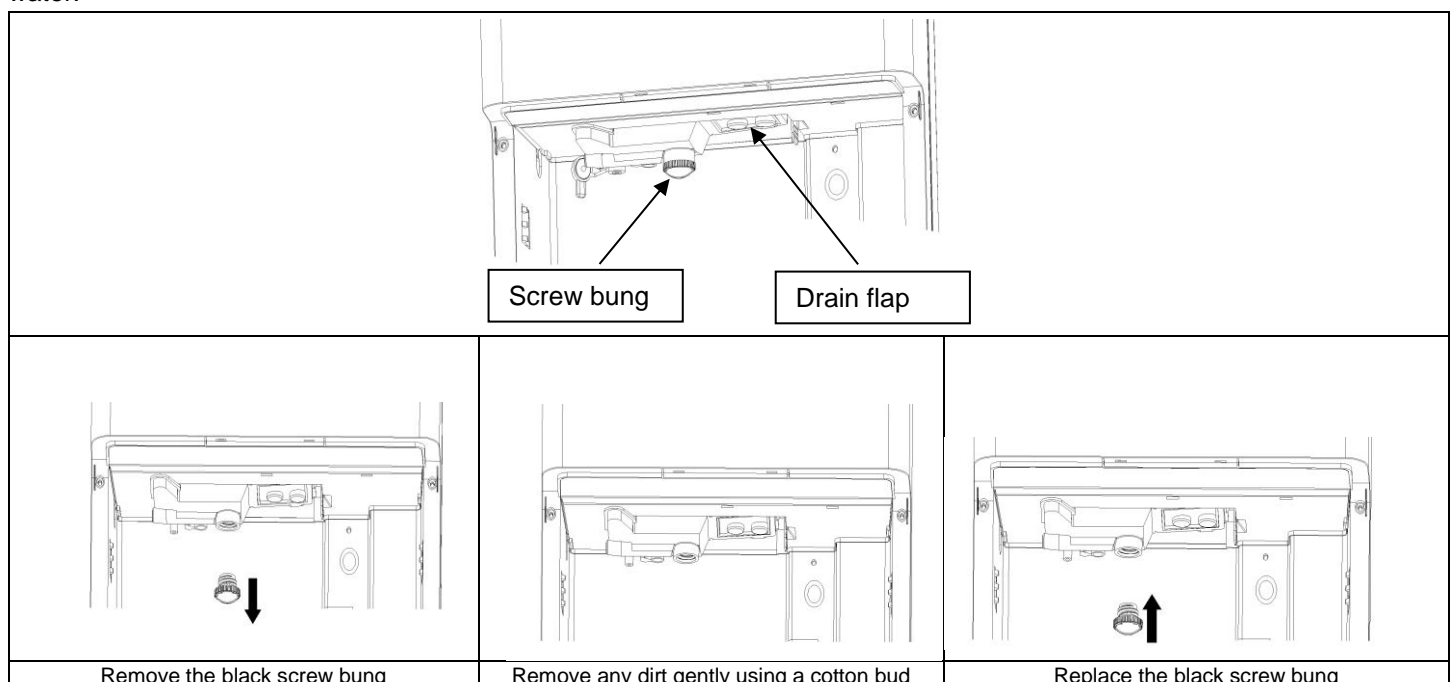

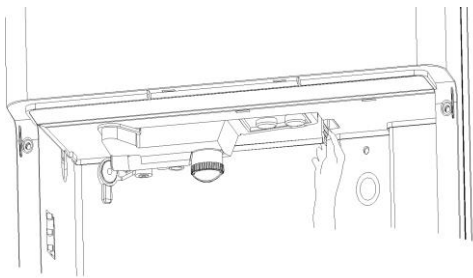
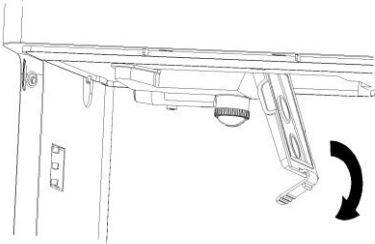
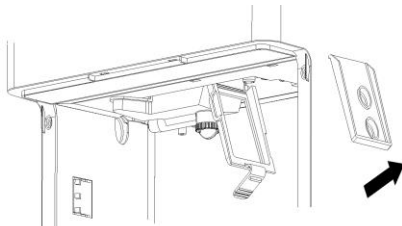
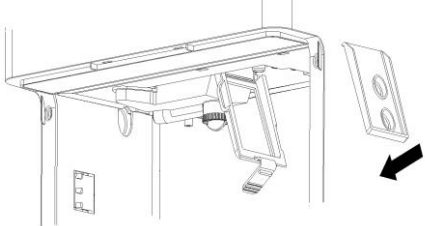
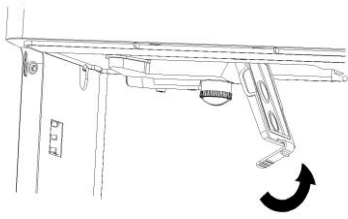
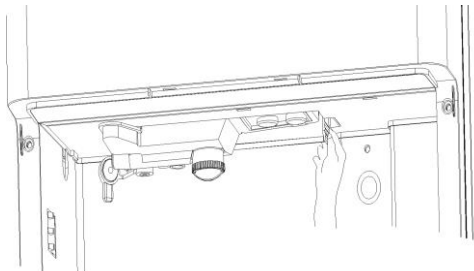
	
<p>Release the flap down using the level on the right hand side</p>	<p>Gently pull the flap to around a 70° angle</p>
	
<p>Remove the black centre piece completely</p>	<p>Once cleaned reinsert the black centre piece</p>
	
<p>Rotate the flap back into position</p>	<p>Close the flap again securely</p>

## 8. SPECIFICATIONS

<b>Model</b>	Meaco DD8L Zambezi Desiccant Dehumidifier
<b>Power consumption</b>	45/350/660 watts
<b>Power supply</b>	220-240V / 50Hz
<b>Capacity water container</b>	3 litres
<b>Air flow</b>	85/105/150m <sup>3</sup> /h
<b>For homes up to</b>	Small 5 bedroom house
<b>Operating range</b>	1 – 37°C
<b>Dimensions (w x d x h)</b>	358 x 200 x 548mm
<b>Net weight</b>	7.8Kgs
<b>Gross weight</b>	9.0Kgs
<b>Sound pressure level</b>	41/45/50dB
<b>Ionisation rate</b>	6x10 <sup>5</sup> m <sup>3</sup>
<b>Ozone rating</b>	0~0.0065ppm
<b>Fuse rating</b>	250V/10A

## 9. TROUBLESHOOTING AND FAULT CODES

If Zambezi displays C1, C2, C3, C4 or if the temperature and relative humidity readout continuously flickers then consult your Meaco approved after sales service centre.

Problem	Cause	Solution
The unit does not work.	The power is not connected.	Insert the plug into the wall outlet.
The device does not dehumidify.	The water container is full.	Remove the water from the container.
	The water container has not been replaced correctly.	Place the water container in the correct position.
	The air filter is clogged.	Clean the air filter.
	The temperature in the room where the dehumidifier is operating is too low.	The machine does not dehumidify below 1°C, it is highly unlikely at that temperature that there is any moisture to remove anyway.
The dehumidifier works, but reduces the relative humidity insufficiently/there is little water in the water tank.	The relative humidity in the room where the dehumidifier is operating is too low.	The dehumidifier dries down to the target relative humidity set and then goes into fan only mode until the relative humidity goes above the set point again.
	The house is too large. This dehumidifier can dry up to about a small five bedroom house.	We recommend using a dehumidifier with a greater capacity.
	There are too many sources of moisture. Bathing, washing, drying clothes and cooking all puts moisture into the air. Portable gas heating can add too much moisture into the air for a dehumidifier.	We recommend using a dehumidifier with a greater capacity. Consider using a different heat source to a portable gas heater.
	There is too much ventilation.	Reduce ventilation (e.g. close windows and shut doors.)
The windows were clear and now condensation has returned.	The air filter is blocked and the reduce air flow is effecting performance.	Clean the air filter.
	The outside air temperature has dropped and the windows are colder.	Set the dehumidifier to a lower target relative humidity so that there is less moisture in the air. Increasing the fan speed will also increase the amount of water collected.
I cannot remove the condensation from my windows, even in 40%rh mode.	The surface temperature of the windows is too low for a dehumidifier to prevent condensation. Common with single glazed windows and when the outside air temperature drops below freezing.	Keep running the dehumidifier on 40%rh 24 hours a day and when the air temperature outside increases the windows should clear of condensation.
		Increasing the fan speed will also increase the amount of water collected.
Dehumidifier is blowing out warm air.	The dried air is passed over a heating element before it is blown into the room as part of the dehumidification process.	This is normal, a dehumidifier is not an air cooler.
Knocking noise coming from the dehumidifier	Motor that rotates the desiccant wheel is low on lubrication.	Run the dehumidifier in Laundry mode for two days to increase the lubrication, if fault persists then call Meaco.
Water not draining down the hose	Hose is fitted for continuous drainage but the water still goes into the tank.	Negative air pressure in the room is pulling the water back into the dehumidifier overflow. Insert a 4mm hole into the top of the tube 30mm down from the spout. This will introduce air into the tube and balance out the air pressure.
Dehumidifier leaks water onto the floor	Usually means that the dehumidifier is not on a level surface or that the filter has not been cleaned often enough and dirt has fallen into the dehumidifier.	You can also check that the water bucket is not cracked by filling it with water and placing it on kitchen paper on the kitchen side.
		Clean away any dirt that is blocking the water as per section seven.
Machine not switching off and on in the usual 30 minute pattern	Temperature and relative humidity sensor that reads the room reading is unable to read the correct readings.	Clean the filter and blow the air sensor with a hair dryer on fast setting to clear the sensor of dirt. Unplug the dehumidifier for 10 minutes to reset it's circuits and then turn back on.
Unit only works in Laundry mode and Laundry light stays on or flashes.	If the humidity sensor is faulty then the dehumidifier will only run in Laundry mode.	Try clearing the sensor as per above line, if that fails then call Meaco for a repair.



## 10. STORAGE

If the machine will not be used for a long period of time, take the following steps:

1. Remove the plug from the socket and empty the container. Allow the container and the dehumidifier to dry completely.
2. Clean the air filter and drain bungs as per section seven.
3. Store the device in a dust-free location away from direct sunlight, preferably covered with a sheet of plastic.

## 11. WARRANTY AND CUSTOMER SERVICE

There is a two year warranty on your dehumidifier from the date of purchase.

All material or manufacturing defects will be repaired free of charge.

The following applies:

- Any repairs or replacement of components during the warranty period will not result in an extension of the warranty period.
- The warranty will expire if any alterations have been made, not genuine components have been fitted or if the dehumidifier has been repaired by a third party.
- Components subject to normal wear and tear, such as the air filter, are not covered by the warranty.
- The warranty is only valid on presentation of the original, unaltered, and date-stamped purchase receipt.
- The warranty does not cover damage caused by actions that deviate from those as described in the user's manual or by neglect.
- The warranty does not cover faults caused by dirt of third party products.
- The warranty does not cover accidental damage.
- All claims for compensation, including consequential damage, will not be entertained.

To prevent unnecessary expenses, we recommend that you always carefully read the user's manual first. If this does not provide a solution, call Meaco and we will be happy to help.

This appliance is not intended for use by person (including children) with reduced physical, sensory or mental capabilities, or lack of experience and knowledge, unless they have been given supervision or instruction concerning use of the appliance by a person responsible for their safety.

Children should be supervised to ensure that they do not play with the appliance.

This dehumidifier has been imported into the European Union by;

Meaco (U.K.) Limited  
Meaco House  
Parklands  
Railton Road  
Guildford  
GU2 9JX

Telephone: 01483 234900  
Email: [sales@meaco.com](mailto:sales@meaco.com)  
Website: [www.meaco.com](http://www.meaco.com)  
Fax: 01483 232700

Please record, for future reference, your date of purchase and where you bought the dehumidifier from here.

Date of purchase.....

Purchased from [www.meaco.com](http://www.meaco.com) (if not then please record the supplier's name below).

.....

Meaco are specialists in dehumidifiers and would welcome your comments and questions on this dehumidifier. If you do develop a fault within the first year then please do call us and if we cannot fix the problem over the phone we will be happy to collect the dehumidifier from you at our expense and repair or replace as appropriate.

Please save the box just in case this happens.

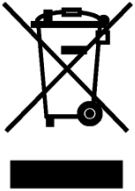

This marking indicates that this product should not be disposed with other household wastes throughout the EU. To prevent possible harm to the environment or human health from uncontrolled waste disposal, recycle it responsibly to promote the sustainable reuse of material resources. To return your used device, please use the return and collection systems or contact the retailer where the product was purchased. They can take this product for environmental safe recycling.



From every Meaco DD8L Zambezi sold £2.00 is donated to the David Shepherd Wildlife Foundation (DSWF) to help in their work to save elephants in the wild. There is actually an elephant called Zambezi who was rescued by the DSWF team in Zambia and is now thriving at their Elephant Orphanage Project where they help elephants return to their natural habitats. We are grateful to artist Jonathan Truss for his drawings of happy and sad Zambezi which feature on the control panel. You can learn more about Jonathan Truss and the DSWF via <http://www.jonathantruss.com/> and <http://www.davidshepherd.org/>.